

ANGLEPOISE®

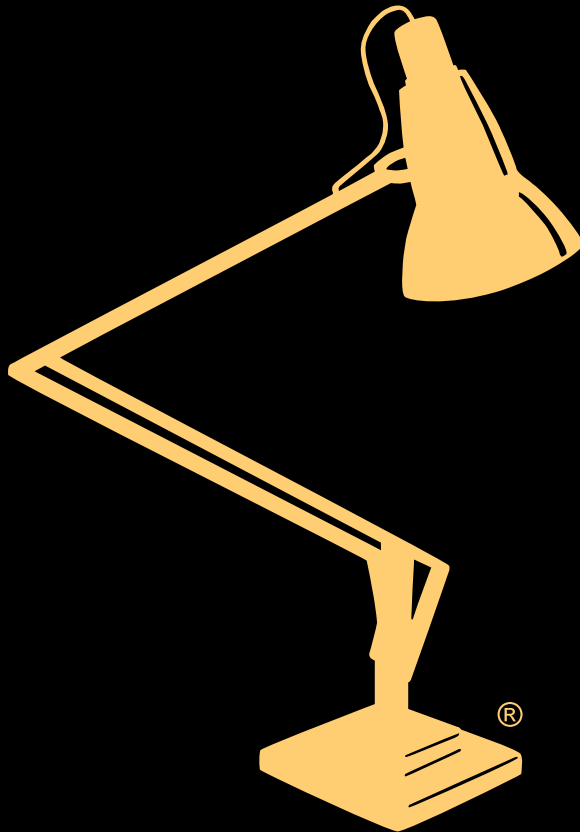

---

est. 1932

## About - 2

- Our Story - 4
- Product Heritage - 6
- George Carwardine - 8
- Sir Kenneth Grange - 9

## Original 1227™ Range - 10

- Original 1227™ Mini - 12
- Original 1227™ - 18
- Original 1227™ Brass - 28
- Original 1227™ Giant - 34
- Original 1227™ Giant Outdoor - 42
- Original 1227™ Giant Brass - 48

## Type 75™ Range - 56

- Type 75™ Mini - 58
- Type 75™ - 64
- Type 75™ Maxi - 70
- Type 75™ Giant - 76

## Type 1228™ Range - 82

## Type C™ LED - 90

## Editions - 94

- Type 75™ Margaret Howell Edition - 96
- Type 75™ Paul Smith Edition One - 100
- Type 75™ Paul Smith Edition Two - 104

## Projects - 108

## Product Index - 118

## Credits - 124

# About Anglepoise®

Characterised by a pioneering perfect balance mechanism developed in the 1930's and an engaging anthropomorphic form, iconic, quintessentially British brand, Anglepoise® produces an incomparable series of premium lighting collections, ideally suited for both home and commercial interiors.

From the creation of our now iconic Original 1227™ lamp, the brainchild of British automotive engineer, George Carwardine ... to the development of extended collections by esteemed industrial product designer, Sir Kenneth Grange ... to our most recent venture, a collaboration with Britain's foremost designer, Paul Smith, incomparable British design is the heart and soul of our company.

Not so surprising then that examples of our lamps can be found in homes and offices, restaurants, bars and hotels - and even in museums - all around the world; nor that the Royal Mail should celebrate our Original 1227™ design alongside such fine British Design Classics as the Mini, Penguin books and the Routemaster Bus.

www.anglepoise.com

@Anglepoise



2009: Royal Mail stamp collection issued to celebrate British Design Classics, includes iconic Anglepoise® Original 1227™ design.



## Our Story

### Invented by a car designer

In 1932 automotive engineer George Carwardine develops a formula for a new type of spring. He discovers that pivoting arms supported by a sequence of these springs can be repositioned with the lightest touch yet will remain perfectly in place once released. Carwardine has just created the blueprint for an Anglepoise®.

### Licensed to a spring maker

Carwardine turns to world-class spring makers Herbert Terry and Sons to manufacture his design. Terry's is one of the few companies able to produce springs of such complexity. The Anglepoise® name is registered and under licence to Terry's the first Anglepoise® lamp, the 4-spring Model 1208 is launched.

### Reworked for a domestic market

Considering the four-spring Anglepoise® too industrial for a domestic market, Carwardine and Terry's designers develop a three-spring version. The Original 1227™ they launch in 1935 is generally considered the archetypal Anglepoise®.

### Practical, efficient & built to last

The flexible Anglepoise® shade is designed to concentrate the beam for maximum efficiency and the durable structure of the lamp is cast in metal. So, when a World War 2 bomber fitted with an Anglepoise® lamp is salvaged from Loch Ness in 1985, remarkably the lamp still works.

### Capturing the Zeitgeist

The anthropomorphic quality of the Anglepoise® lamp design has long inspired musicians, artists, designers and writers. In 1977 amateur filmmaker Peter Ryde releases 'Wranglepoise', a charming video short that brings the very human characteristics of the lamp into the limelight.



### Maintaining design excellence

Having previously identified the Anglepoise® as a 'minor miracle of balance' in 2003, esteemed British industrial product designer Sir Kenneth Grange, responsible for some of Britain's most iconic and successful designs including the Kodak Instamatic, the Intercity 125 train and the updated London taxi, becomes Design Director of Anglepoise®.

### A champion of modernism

In 2004 renowned British fashion designer Margaret Howell, a longstanding admirer of British modernism, launches a limited edition, re-coloured version of Grange's Type 3™ desk lamp. A subsequent collaboration sees an exclusive Type 75™ desk and floor lamp reworked in yellow ochre.

### Enter the big friendly Giant

Anglepoise® is approached by the Roald Dahl Museum & Story Centre to produce a larger-than-life version of the writer's beloved Original 1227™ desk lamp. The Original 1227™ Giant generates considerable interest and is soon in volume production. 2016 marks the evolution of the Giant into a substantial collection.

### Achieving design classic status

In 2009, in recognition of its iconic status, the Original 1227™ is featured on a Royal Mail stamp set alongside other pioneering British designs, including the Routemaster Bus, the K2 Telephone Kiosk, the London Underground Map and the Mini.

### Innovation continues

In 2014, foremost British designer Paul Smith begins an on-going collaboration with Anglepoise®, continuing an illustrious design heritage for the brand. The Type 75™ table lamp, designed by Sir Kenneth Grange in 2006, provides the perfect canvas for Paul Smith's masterful colour-by-component approach.

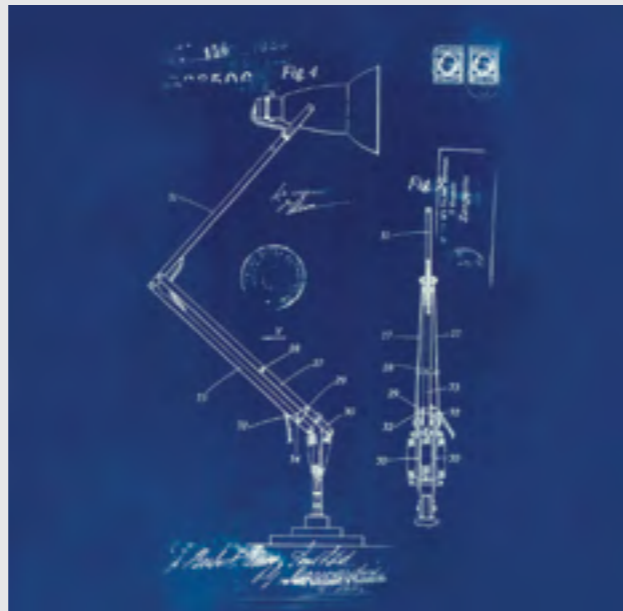

# Product Heritage



Anglepoise® has been making its signature sprung lamps since 1932. This pictorial timeline charts the development of an iconic brand.



**Prototype**  
1932



**Model 1208**  
1933



**Apex 90**  
1985



**Type 3™**  
2003



**Model 1227**  
1935



**Model 1227**  
1946



**Type 75™**  
2004



**Type 1228™**  
2008



**Model 75**  
1968



**Model 90**  
1973



**Type 75™ Mini**  
2011



**Original 1227™ Mini**  
2015



## George Carwardine

George Carwardine (1887 - 1947) didn't need to invent the Anglepoise® lamp to make his name; he was already a practicing engineer of some note, specialising in vehicle suspension systems. He honed his skills at the Hortsman Car Company where he rose through the ranks to become Chief Designer. Then in 1924, when Hortsman's got into financial difficulties Carwardine left to start his own business, which he called Cardine Accessories.

He later went back to work with Sydney Hortsman but in 1929 the Horstman car company went bankrupt. Carwardine seized the moment – here was the opportunity he'd been waiting for to explore a longstanding fascination with spring and lever based mechanisms. He established a garden workshop at his home in Bath and began work on the design that would later become his legacy.

By 1932 Carwardine was ready to unveil his remarkable invention - a 4-spring lamp, combining unprecedented freedom of movement and perfect balance due to its patented constant spring mechanism. And soon demand for the lamp far outstripped Carwardine's small-scale supply. So in 1934 Carwardine licensed the design to world-class spring maker, Herbert Terry & Sons, who already supplied the springs for his lamps. Not long after, the Anglepoise® name was registered and the 4-spring 'Model 1208' went into volume production.

Carwardine and the designers at Terry's went straight back to the drawing board, intent on reworking the industrial-style 4-spring design for a domestic market. In 1935 a 3-spring Anglepoise® lamp was released. This was the Original 1227™ - the same design produced to this day.



## Sir Kenneth Grange

Design Director of Anglepoise® since 2003, Sir Kenneth Grange began his illustrious career as a technical illustrator whilst in National Service. He subsequently made his reputation as an industrial product designer and in association with four partners founded Pentagram, now an international design practice with offices in USA, Germany and London.

Grange's remarkable work spans half a century and his user-centered, often quintessentially British designs have helped shape the parameters of everyday life for so many. Not only everyday household brands like Kenwood, Parker, Kodak - and of course Anglepoise® - have received the Kenneth Grange treatment but also the InterCity 125 train, the regional Royal Mail postbox and the latest London Black Taxi.

Accolades for Grange's influence as a foremost British product designer have naturally followed. Twice winner of the Prince Philip Designers Prize with a string of Design Council Awards to his name, Grange is a Royal Designer for Industry, Gold Medalist of the Chartered Society of Designers, holds six Honorary Doctorates including at the Royal College of Art where he is visiting professor and an FX Lifetime Achievement Award. In 1983 the Victoria & Albert Museum staged a one-man show of his work. Grange was similarly honored in Tokyo in 1989 and again at the Design Museum 'Making Britain Modern' exhibition in London in 2011. In 1984 Grange was appointed CBE and in 2013 he received a knighthood for services to design.

Having previously identified the Anglepoise® as his favourite design and a 'minor miracle of balance', Sir Kenneth Grange became Design Director of Anglepoise® in 2003. His first Anglepoise® design was the Type 3™ desk lamp, which launched in 2003.

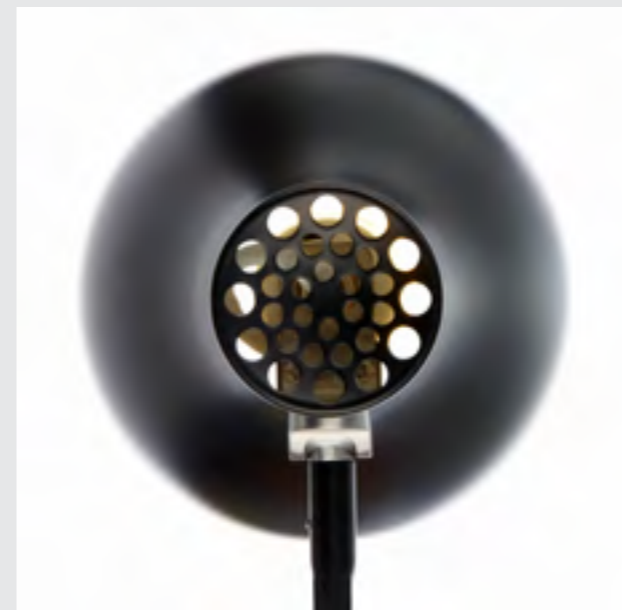
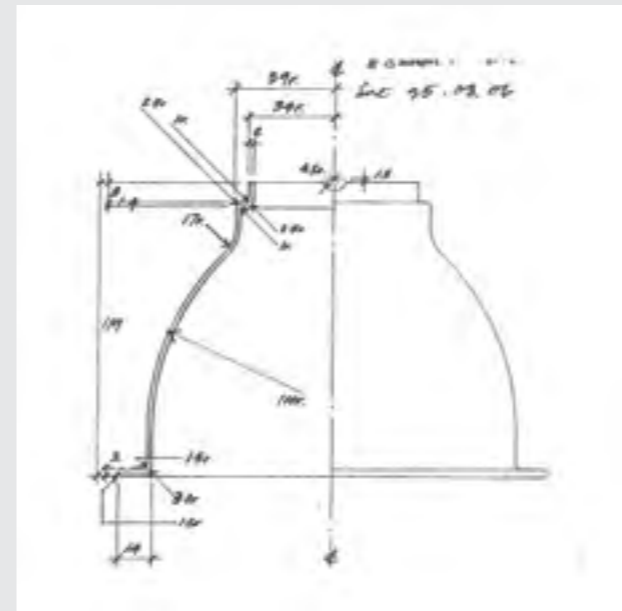
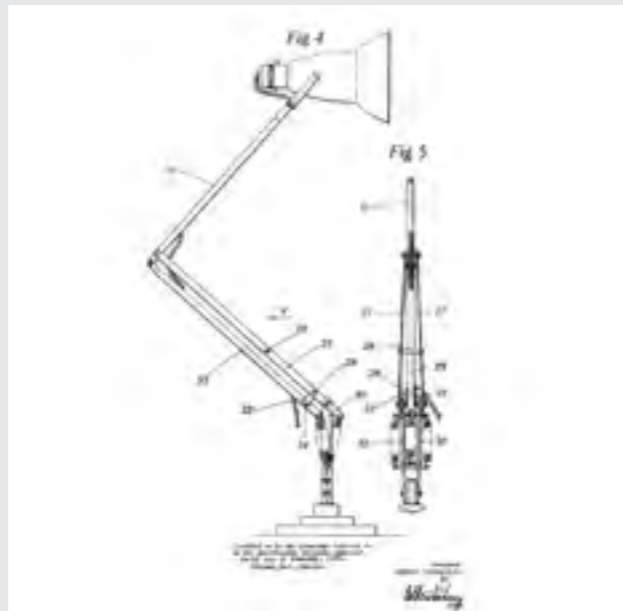

## Original 1227™

---

First launched in 1935, the Original 1227™ set the standards by which other desk lamps were measured. Its ingenious spring and lever mechanism invented a few years earlier by automotive engineer George Carwardine, meant that the Original 1227™ combined ultimate flexibility with perfect balance. Now sensitively updated for modern life, the Original 1227™ has become a design classic (it's even appeared on a set of Royal Mail stamps), beloved by design aficionados around the world. The on-going popularity of Carwardine's creation is testament both to the brilliance of his original design and our commitment to maintaining its unrivalled functionality and unique, iconic identity across the entire Original 1227™ portfolio.



## Original 1227™ Mini Collection

---

The four-piece Original 1227™ Mini Collection is the latest, and smallest, addition to the Original 1227™ family. Diminutive but not diminished, it is playful, versatile, classic and 100% authentic, boasting traditional chrome fittings, our traditional shade shape and plaques etched with the Anglepoise® logo.







Original 1227™ Mini Collection  
Designed by George Carwardine

- Desk Lamp - A
- Table Lamp - B
- Wall Mounted Lamp - C
- Wall Light - D

Colours

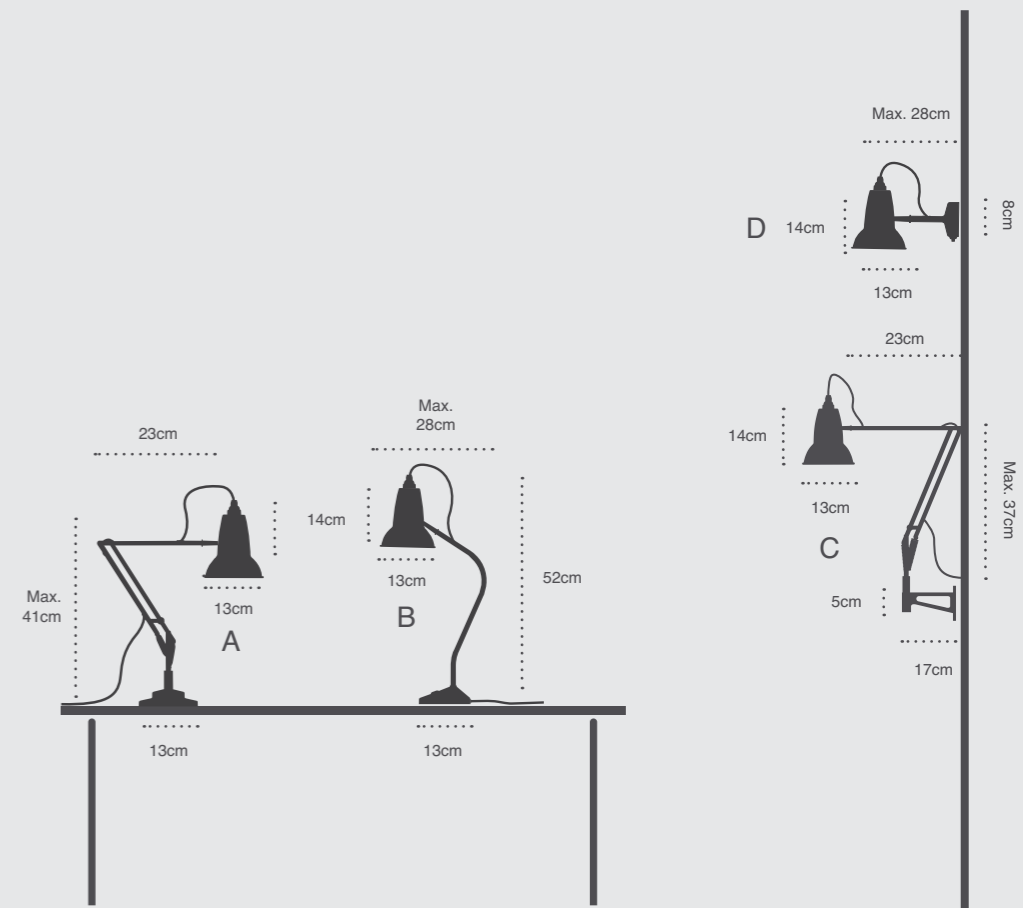

## Original 1227™ Collection

---

Our Original 1227™ Collection began with a desk lamp. Today, this highly adaptable and engagingly anthropomorphic light, is part of an exemplary nine-piece collection designed for different locations, from table and wall to ceiling and floor. Each piece is available in up to five classic colours, including a new Linen White and Dove Grey, and comes with toning fabric-covered cord and traditional chrome fittings. Our Original 1227™ Collection has always boasted unrivalled functionality; now it boasts unrivalled choice too.















**Original 1227™ Collection**  
Designed by George Carwardine

- Desk Lamp - A
- Table Lamp - B
- Floor Lamp - C
- Fixed Floor Lamp - D
- Pendant - E
- Midi Pendant - F
- Maxi Pendant - G
- Wall Mounted Lamp - H
- Wall Light - I

**Colours**

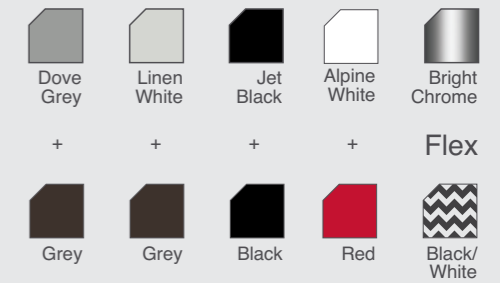

Please note Alpine White Desk, Wall Mounted & Floor Lamp have Bright Chrome Arms. Additional Pendant cable lengths available on request.

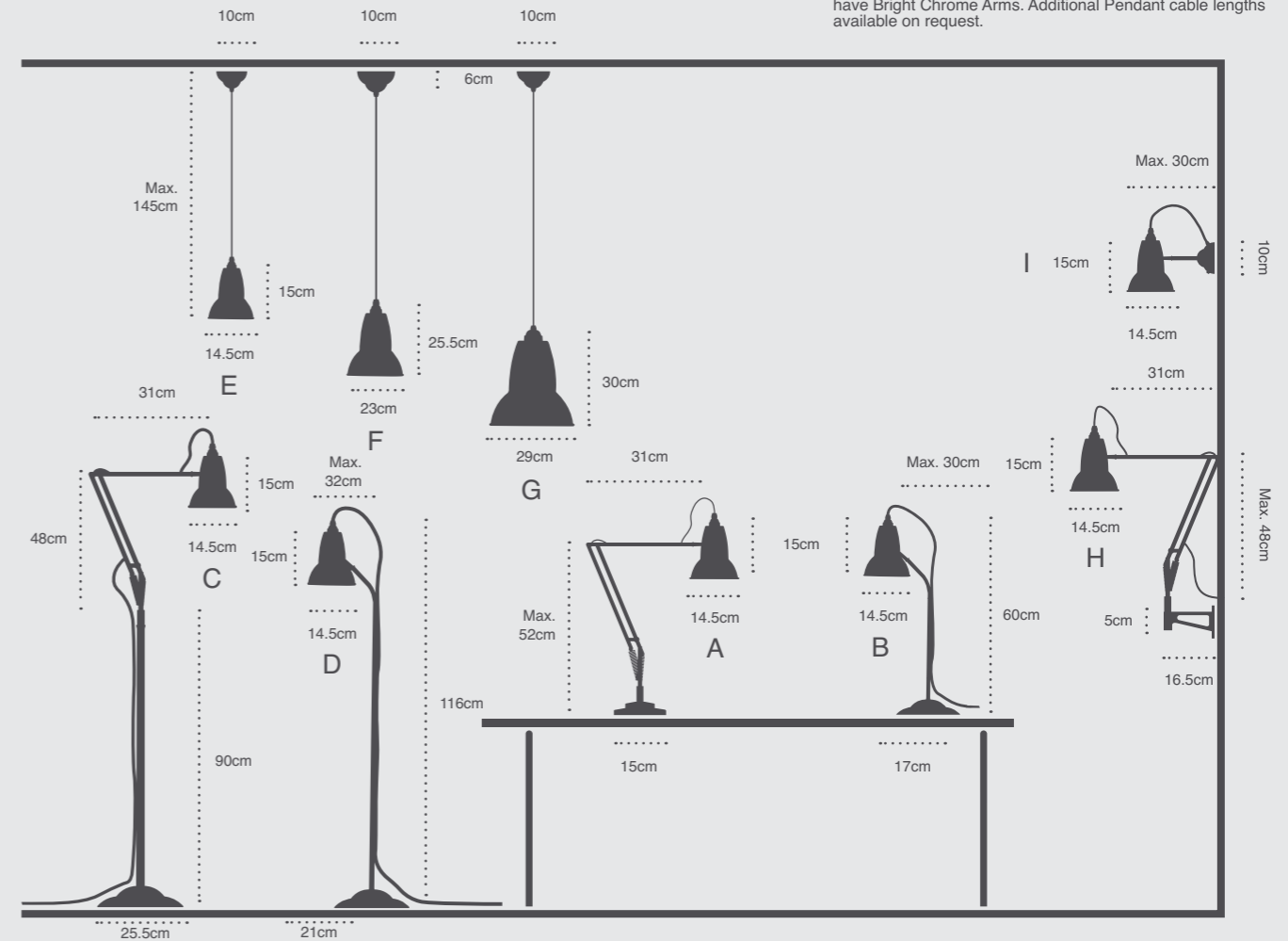

## Original 1227™ Brass Collection

With its beautiful, solid brass components, woven fabric cable and chic, high gloss colour palette, this premium five-piece collection is a sophisticated reinterpretation of our classic Original 1227™ design. A perfect blend of form and function, the pendants make a striking feature, while the wall and desk lamps can be re-positioned with the slightest touch and come with adjustable shades that focus the light precisely where it's needed.







**Original 1227™ Brass Collection**  
 Designed by George Carwardine

- Desk Lamp - A
- Pendant - B
- Maxi Pendant - C
- Wall Mounted Lamp - D
- Wall Light - E

Colours



Additional Pendant cable lengths available on request.

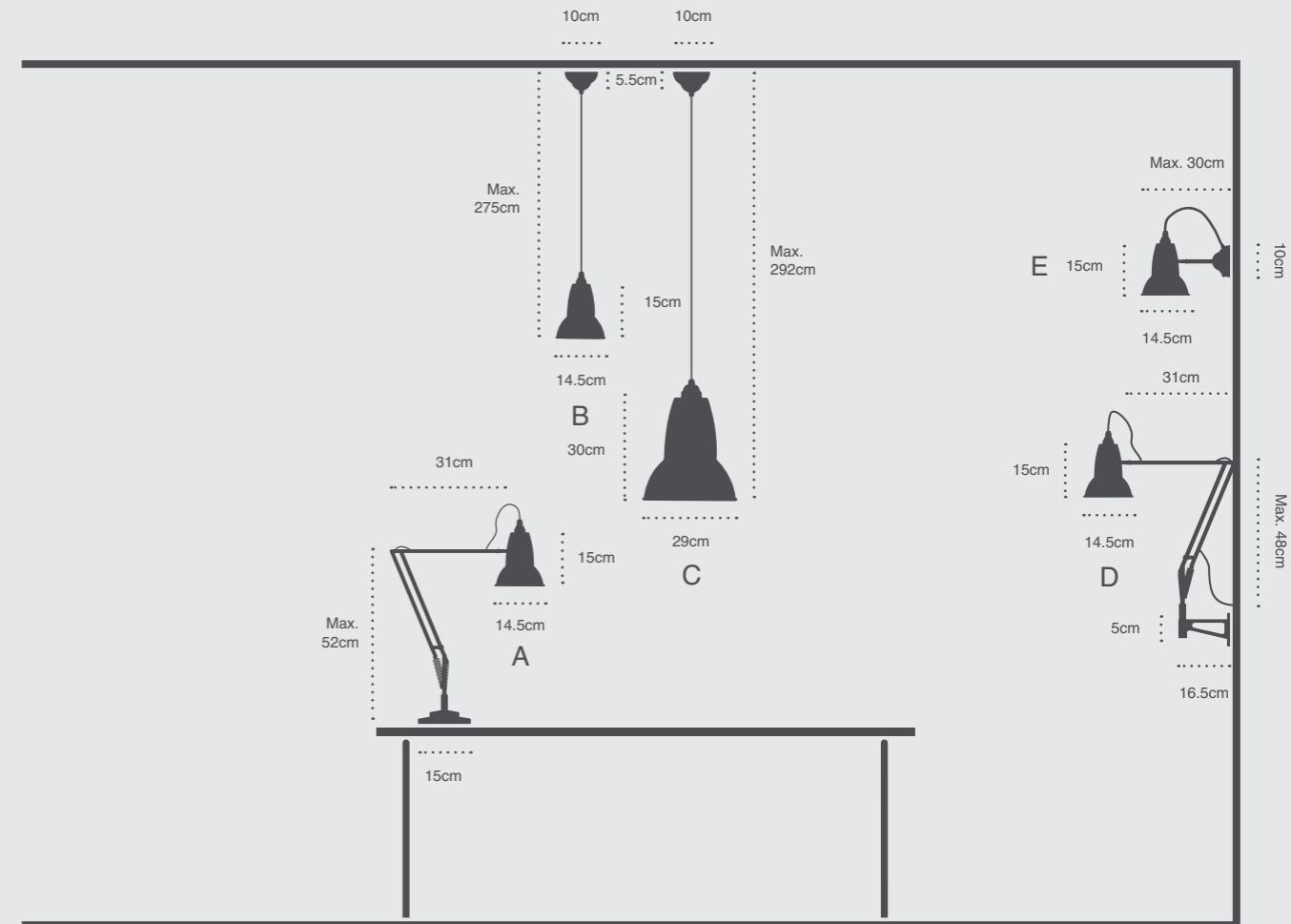

## Original 1227™ Giant Collection

The Original 1227™ Giant floor lamp is a beautifully crafted, functional light and an impressive, illuminated sculpture. Three times the size of our iconic Original 1227™ design, it is available in 15 stunning colours, plus custom options, and will introduce an element of playful, individual style into any interior space. Team with our coordinating pendant shade and new articulated wall-mounted lamp for maximum impact.











**Original 1227™ Giant Collection**  
 Designed by George Carwardine

Floor Lamp - A  
 Pendant - B  
 Wall Mounted Lamp - C

**Colours**

Gloss Finish



Satin Finish



Custom colours also available, details & price on application.  
 Additional Pendant cable lengths available on request.

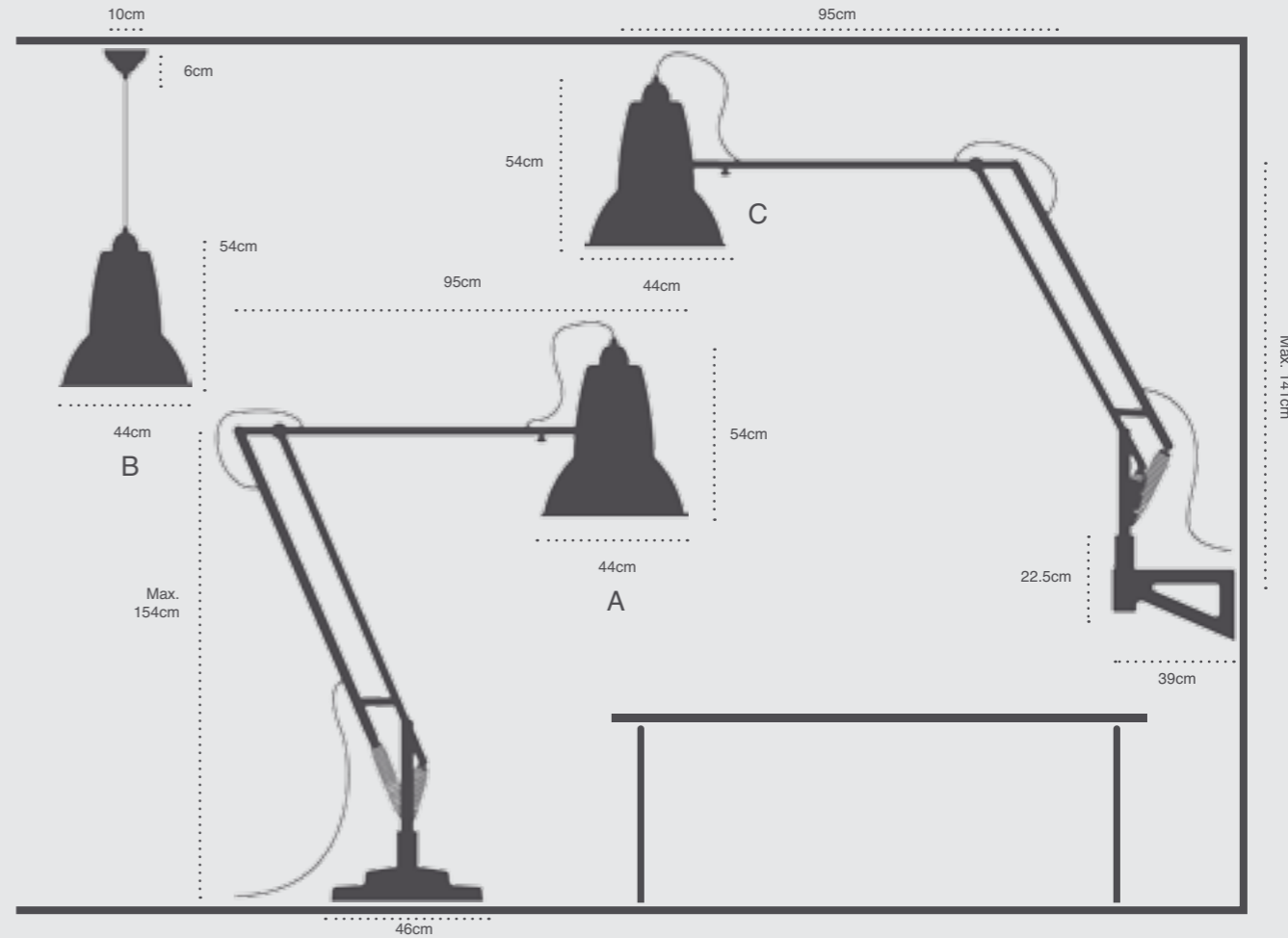



## Original 1227™ Giant Outdoor Collection

Our tremendously successful and much loved Original 1227™ Giant range has been re-engineered for outdoor environments. Marine-grade stainless steel fittings combine with a sealed housing to enable the Giants to venture outdoors. Big enough to make a statement, but flexible enough to work in smaller areas too, both the floor lamp and our articulated wall light help to bring the inside out, turning exterior spaces into striking al fresco rooms.









**Original 1227™ Giant Outdoor Collection**  
 Designed by George Carwardine

Floor Lamp - A  
 Wall Mounted Lamp - B



**Colours**

Gloss Finish



Satin Finish



Custom colours also available, details & price on application.

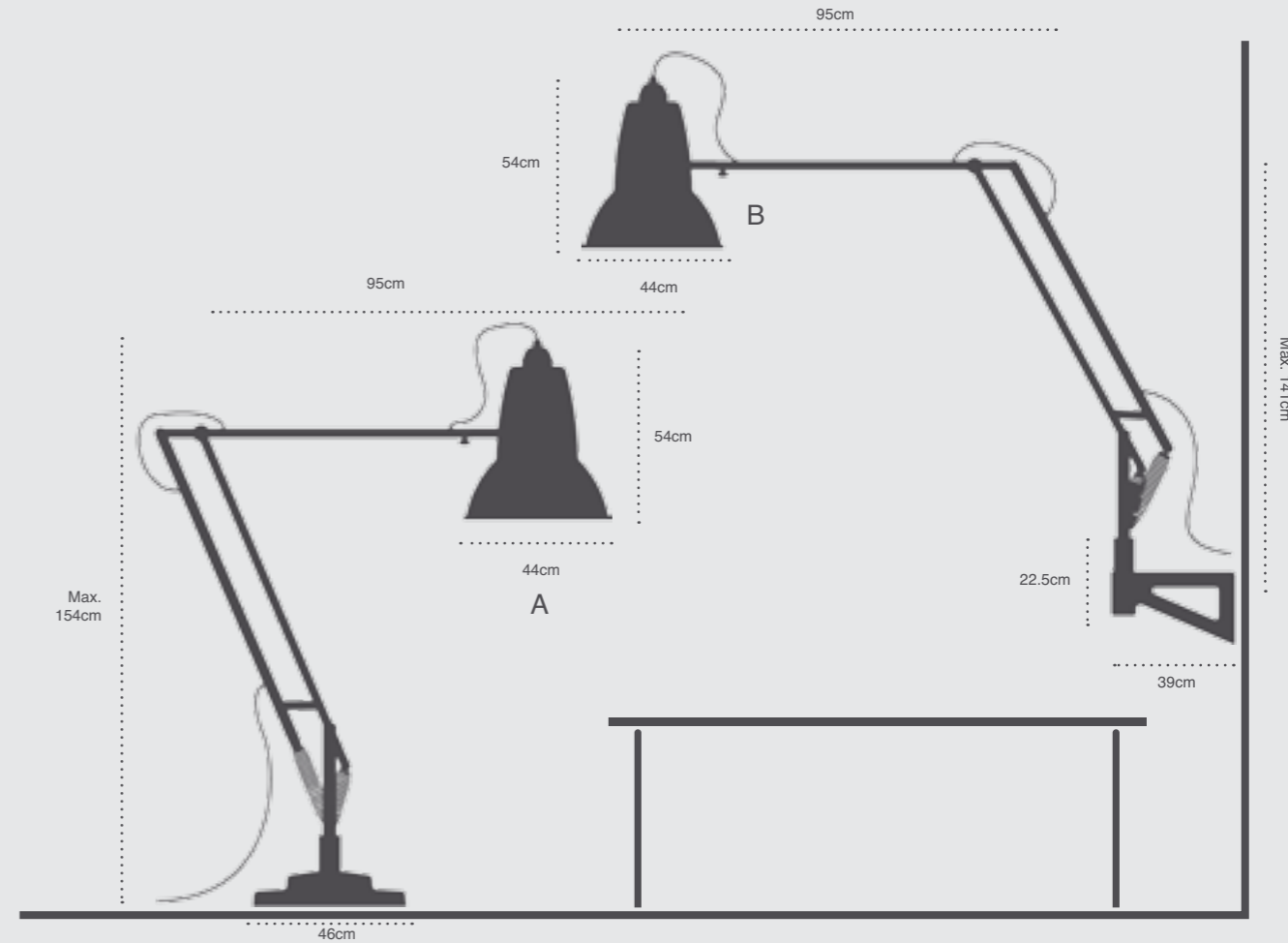

## Original 1227™ Giant Brass Collection

A super-sized version of the Original 1227™ Brass, our new Brass Giant Collection is a real showstopper. High end details such as finely crafted, solid brass components and fabric-covered cable create a luxurious aesthetic across the range (which consists of a floor lamp, wall mounted light and pendant), while the solid brass block on both the floor and wall lamps is a serious feature in its own right. Built to last, these are investment pieces; beautiful additions to the Anglepoise® family.

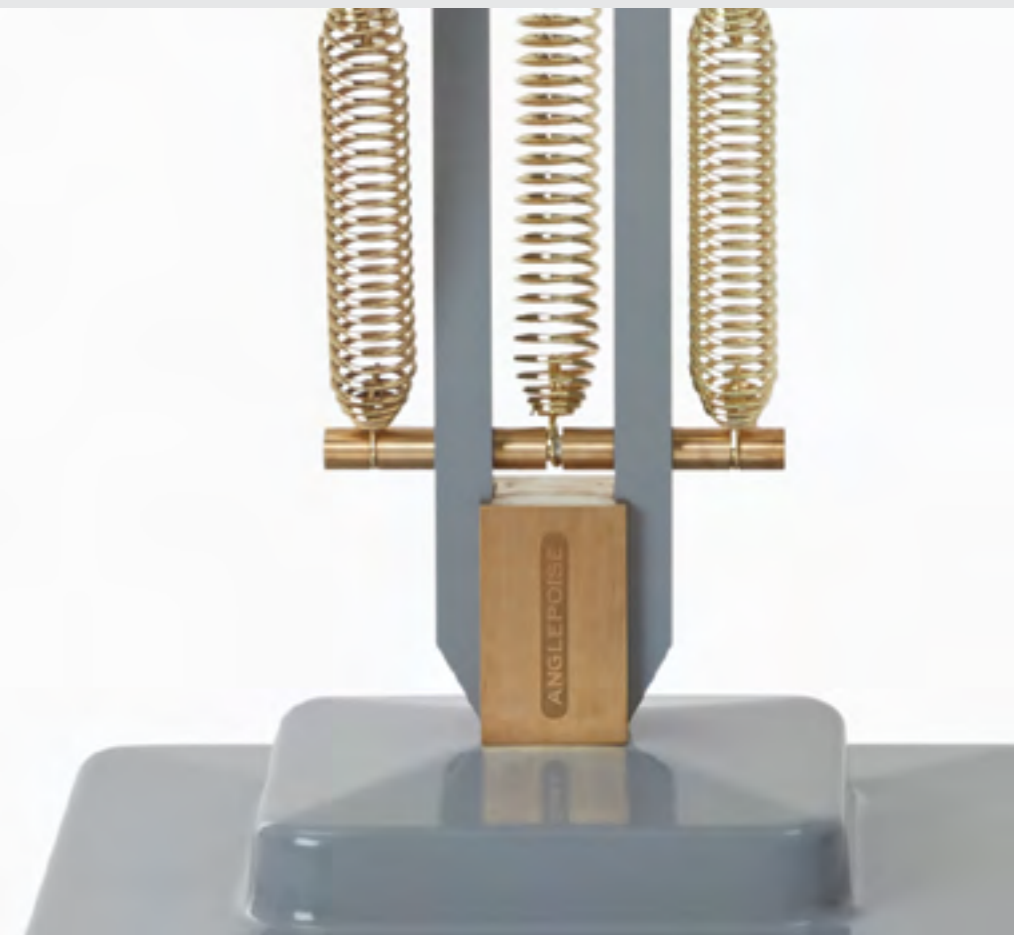











**Original 1227™ Giant Brass Collection**  
 Designed by George Carwardine

- Floor Lamp - A
- Pendant - B
- Wall Mounted Lamp - C

Colours



Custom colours also available, details & price on application. Additional Pendant cable lengths available on request.

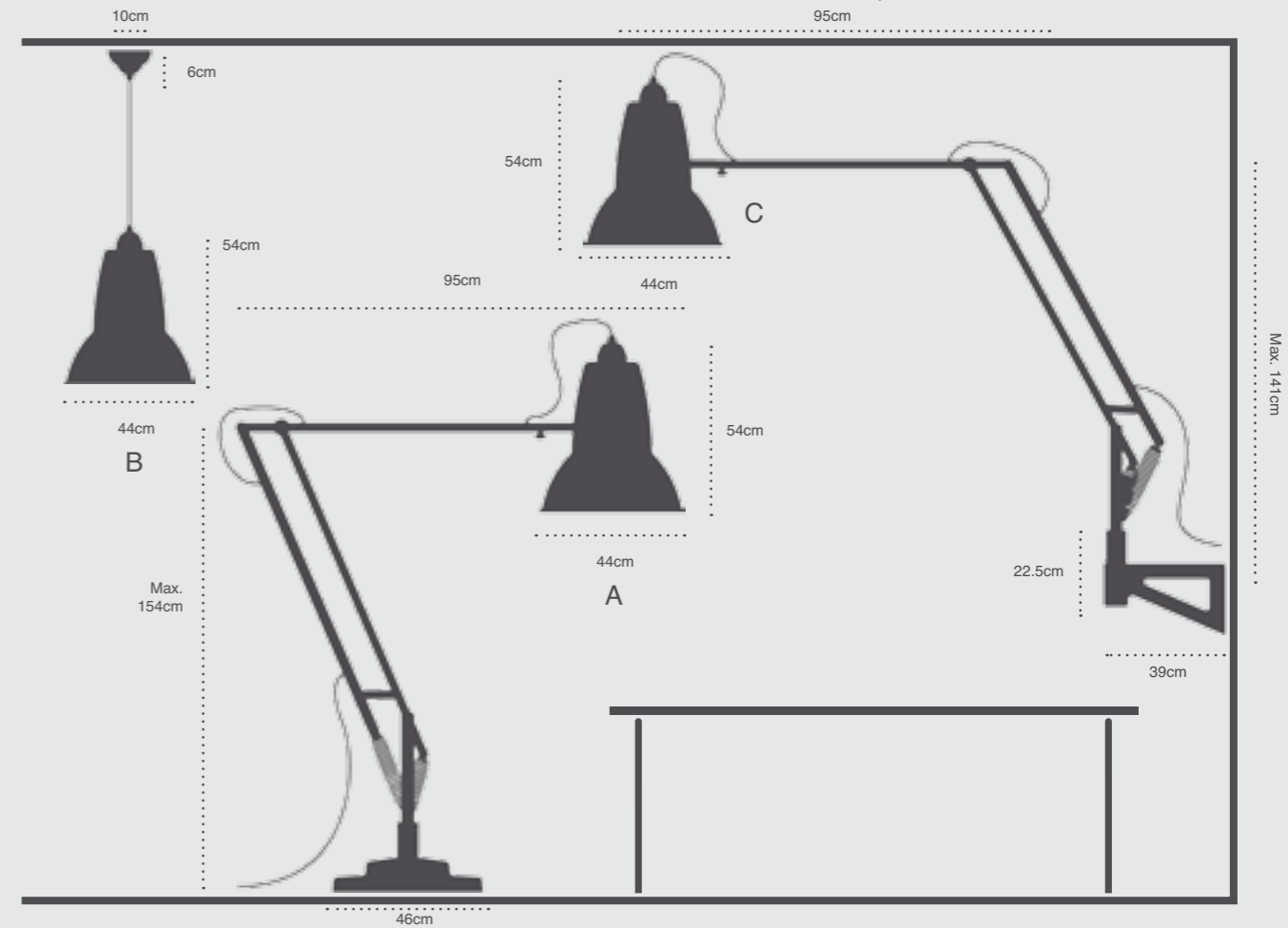



## Type 75™

---

Created by Sir Kenneth Grange, the Type 75™ is a modern design classic; a confident blending of form and function. Clean, modernist lines combine with the perfect balance and fantastic range of movement that our unique constant tension spring mechanism makes possible (the shade can be positioned with a fingertip touch, but once in place, it will stay there). Coordinated across four collections of varying scale from the diminutive Mini to the striking, new Type 75™ Giant floor lamp, the Type 75™ has become our best-selling collection around the world; its contemporary aesthetic proving equally popular with both domestic and commercial markets.



## Type 75™ Mini Collection

---

Sir Kenneth Grange's Type 75™ Mini collection offers all the functionality of its larger sibling, but in a more compact and colourful form, making it a popular choice for smaller spaces. The desk, floor and wall mounted lamps incorporate Anglepoise® constant tension spring technology for matchless flexibility and perfect balance. They are complemented by a neat and versatile wall lamp.







**Type 75™ Mini Collection**  
 Designed by Sir Kenneth Grange

- Floor Lamp - A
- Desk Lamp - B
- Lamp with Desk Insert - C
- Lamp with Desk Clamp - D
- Wall Mounted Lamp - E
- Wall Light - F

Colours

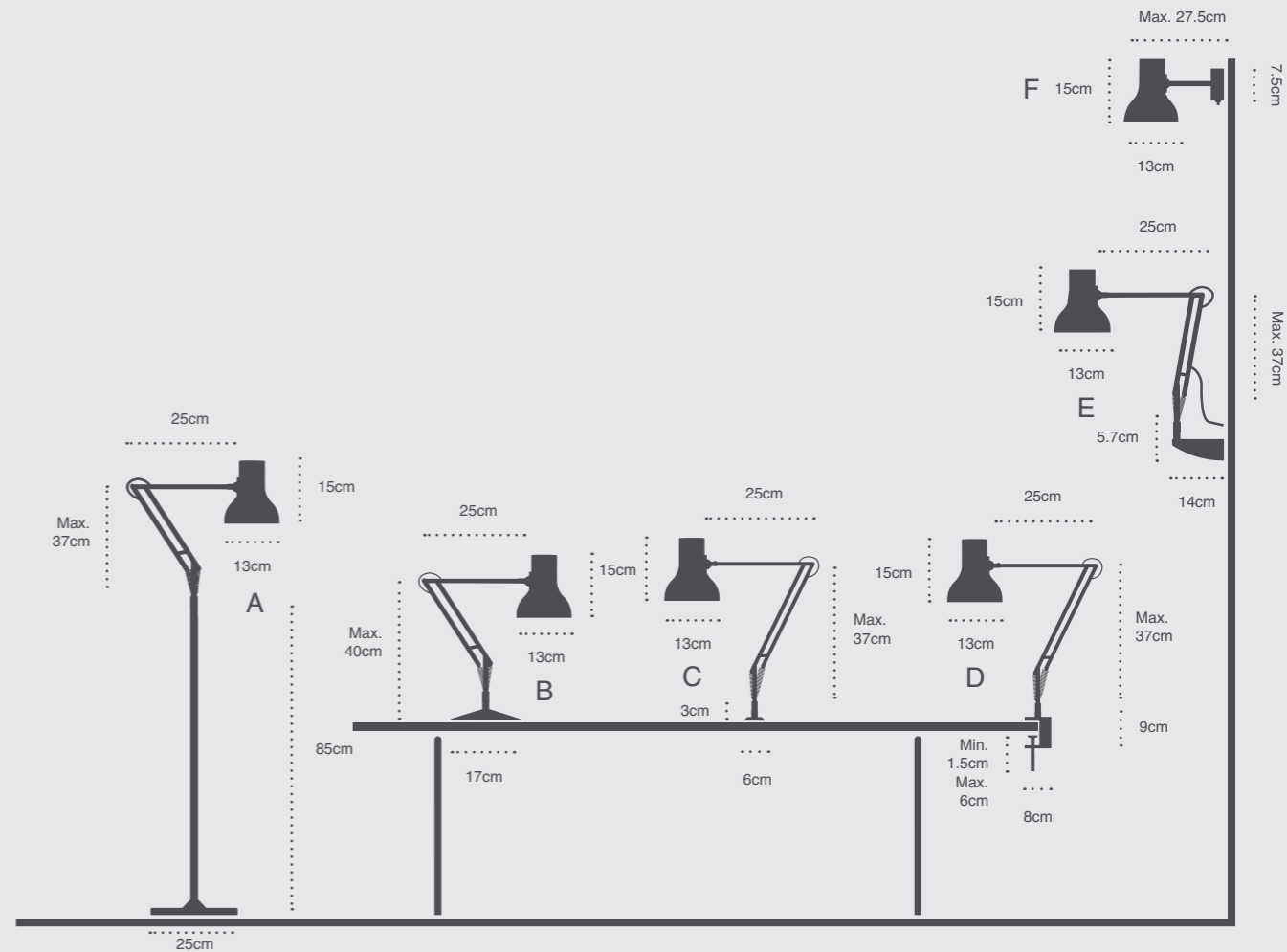
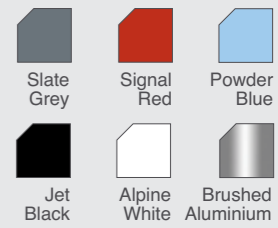



## Type 75™ Collection

With its clean lines, flowing movement and flawless balance, Sir Kenneth Grange's Type 75™ reinterprets the original Anglepoise® design for the 21st Century. The pared-back aesthetic means that this six-piece range is at home anywhere, from hotel to home office; a fact that has helped to make the Type 75™ our bestselling collection across the globe. The smoothly-shaped shade, with its attractive stylised vents, can be moved into multiple positions, while the Anglepoise® unique constant tension spring mechanism guarantees that it will be a pleasure to use.







**Type 75™ Collection**  
 Designed by Sir Kenneth Grange

- Floor Lamp - A
- Desk Lamp - B
- Lamp with Desk Insert - C
- Lamp with Desk Clamp - D
- Wall Mounted Lamp - E
- Wall Light - F

Colours

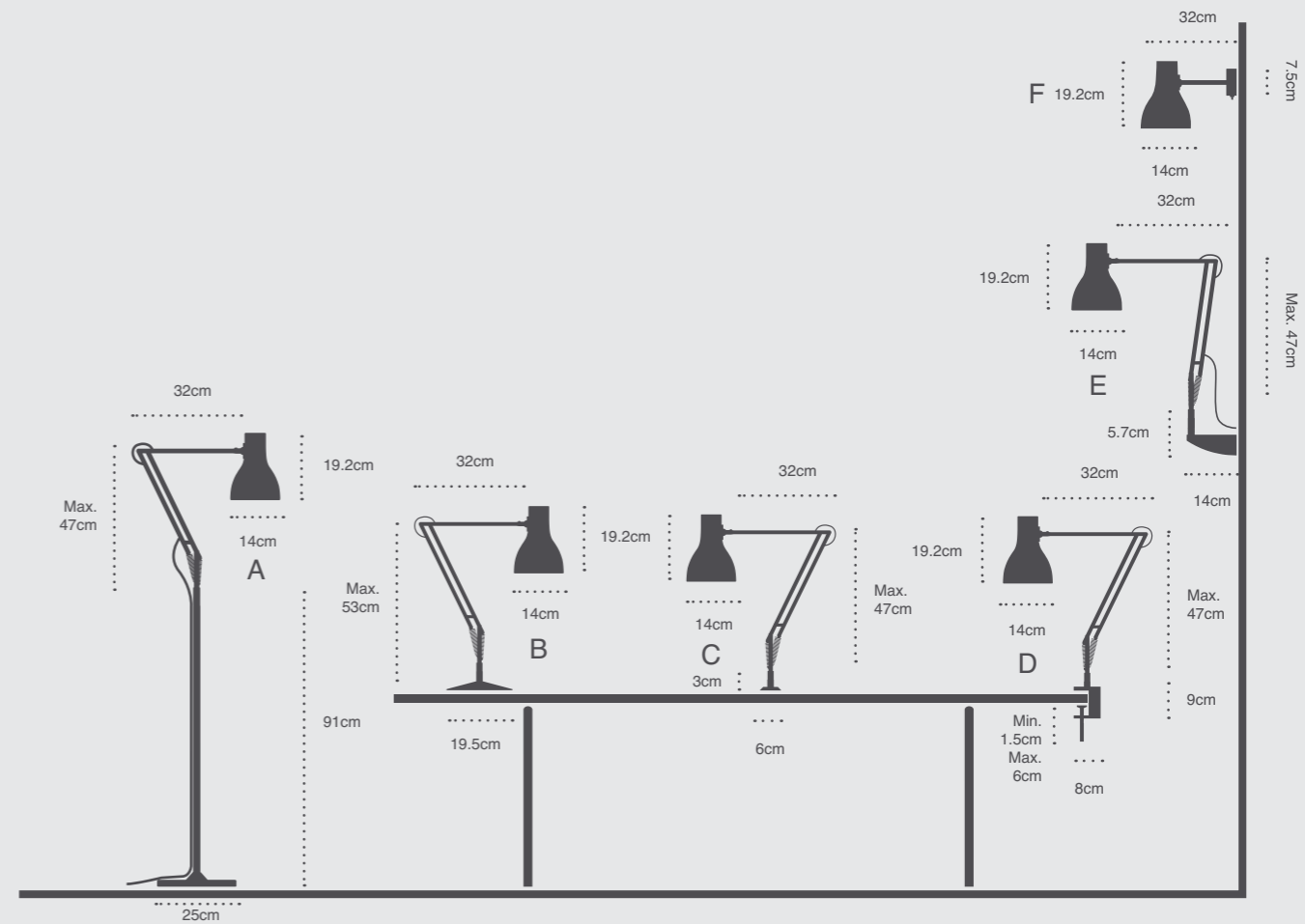



## Type 75™ Maxi Collection

The striking Type 75™ Maxi floor lamp has been beautifully engineered and built to exacting Anglepoise® standards, ensuring that this up-scaled version of Sir Kenneth Grange's bestselling design offers unrivalled adjustability, smooth movement, perfect balance and maximum stability. The bold shade shape is reflected in a coordinating Type 75™ Maxi pendant, with subtle metallic detail and stylish light escape feature.







**Type 75™ Maxi Collection**  
Designed by Sir Kenneth Grange

Floor Lamp - A  
Pendant - B

Colours

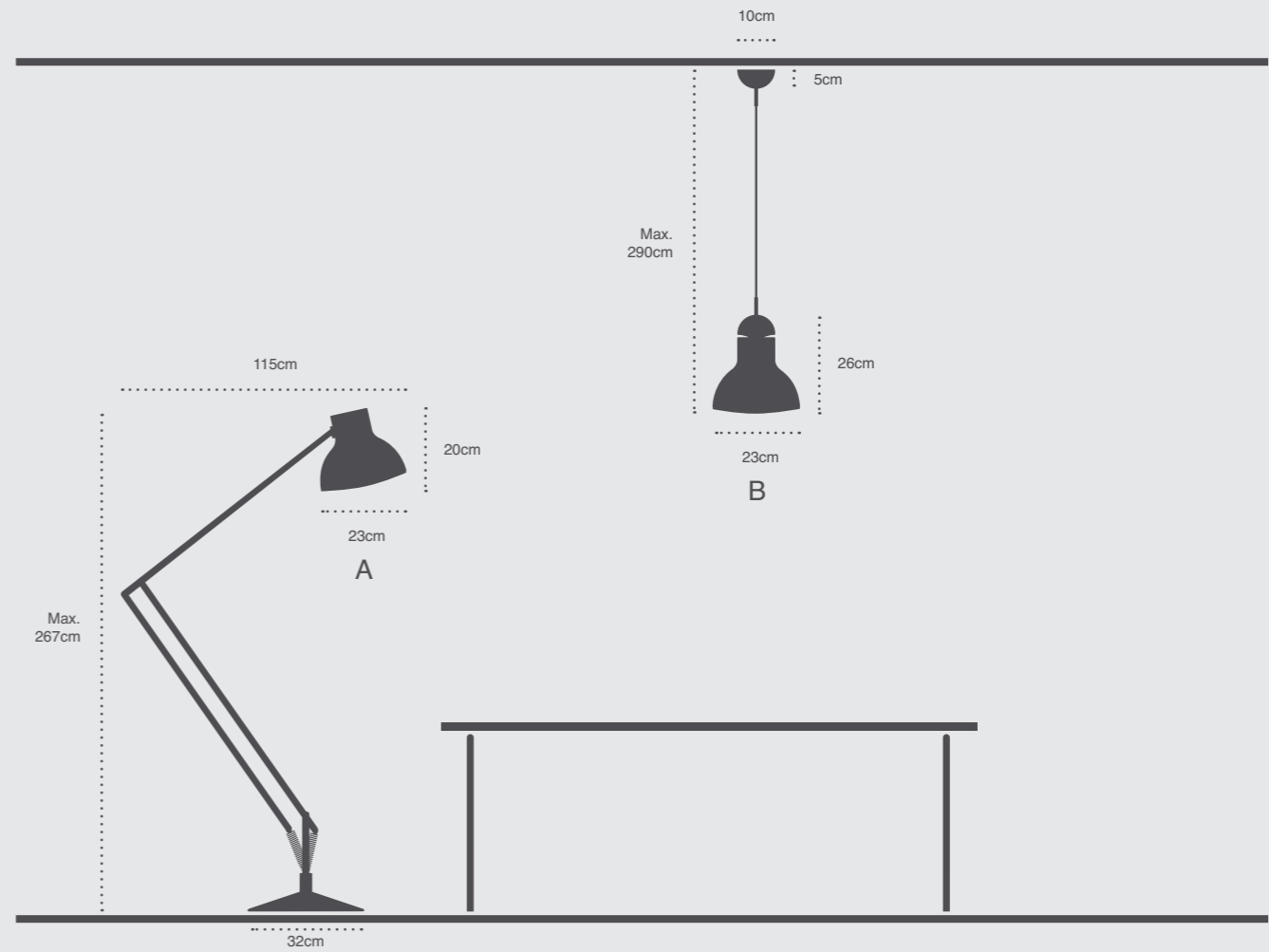



## Type 75™ Giant Collection

Three times the size of Sir Kenneth Grange's classic Type 75™ desk lamp, our new Type 75™ Giant floor lamp, in brushed aluminium or satin powder finish, is a striking, modernist alternative to the Original 1227™ Giant. Featuring precision machined components and a rotating shade that offers not only a switched bulb system to allow for multiple light levels, but also unique halo-effect illumination, this is a statement piece that is as functional as it is beautiful.

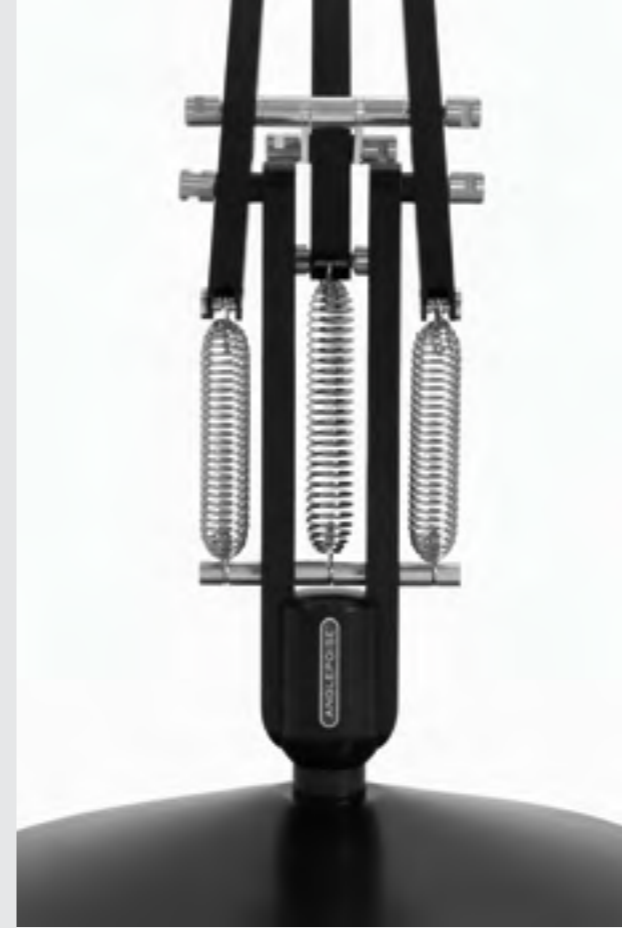





**Type 75™ Giant Collection**  
Designed by Sir Kenneth Grange

Floor Lamp - A



Colours

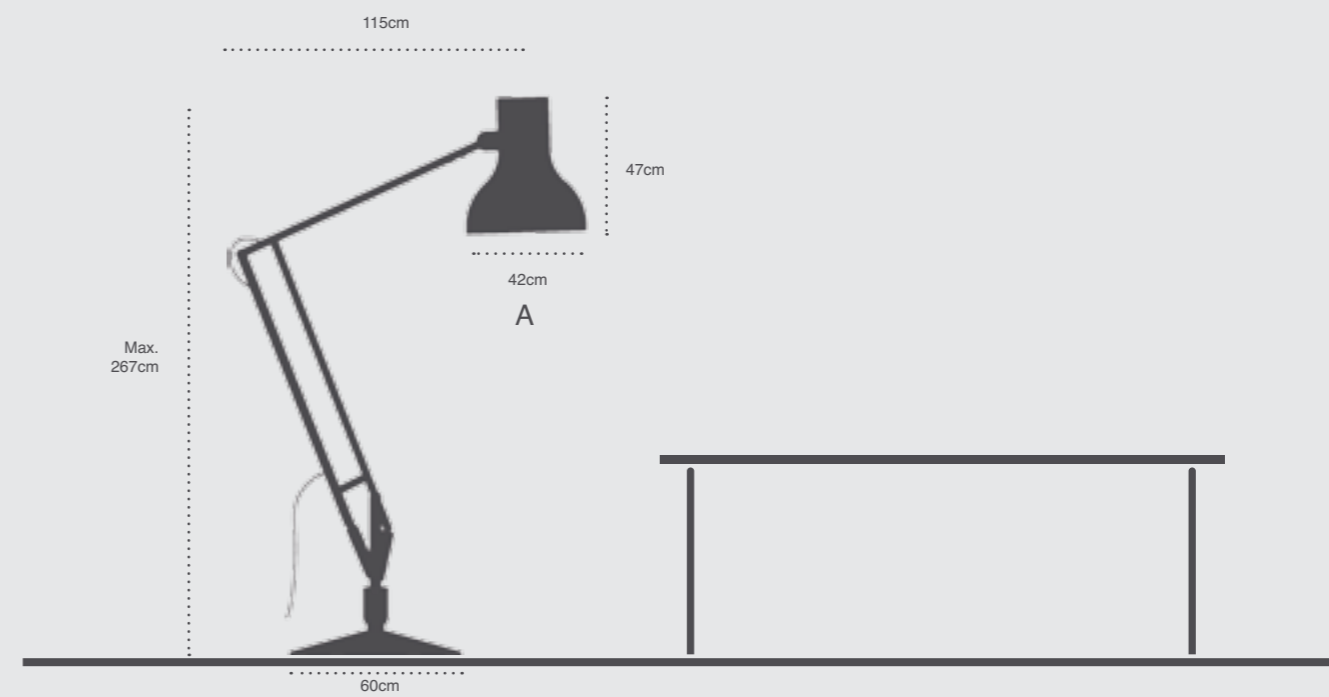
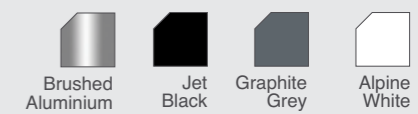

## Type 1228™

Sir Kenneth Grange's, Type 1228™ is one of the most versatile designs in our portfolio. The special Anglepoise® constant tension spring mechanism allows for maximum control and guarantees perfect balance, while almost 360° shade rotation makes it ideal for both ambient and directional lighting. Fitted with an integral switch and available in an exciting range of translucent colours that change when the light is switched on, our Type 1228™ is a vibrant and practical addition to the Anglepoise® family.





## Type 1228™ Collection

---

Our six-piece Type 1228™ Collection offers all the functionality you would expect from Anglepoise®, combined with a more contemporary aesthetic. Sir Kenneth Grange's attractive bowl-like shade, which boasts an integral switch, comes in a range of translucent colours that change when the light is on and can be rotated to offer both ambient and directional lighting.







**Type 1228™ Collection**  
 Designed by Sir Kenneth Grange

- Floor Lamp - A
- Desk Lamp - B
- Lamp with Desk Insert - C
- Lamp with Desk Clamp - D
- Wall Mounted Lamp - E
- Wall Light - F

Colours

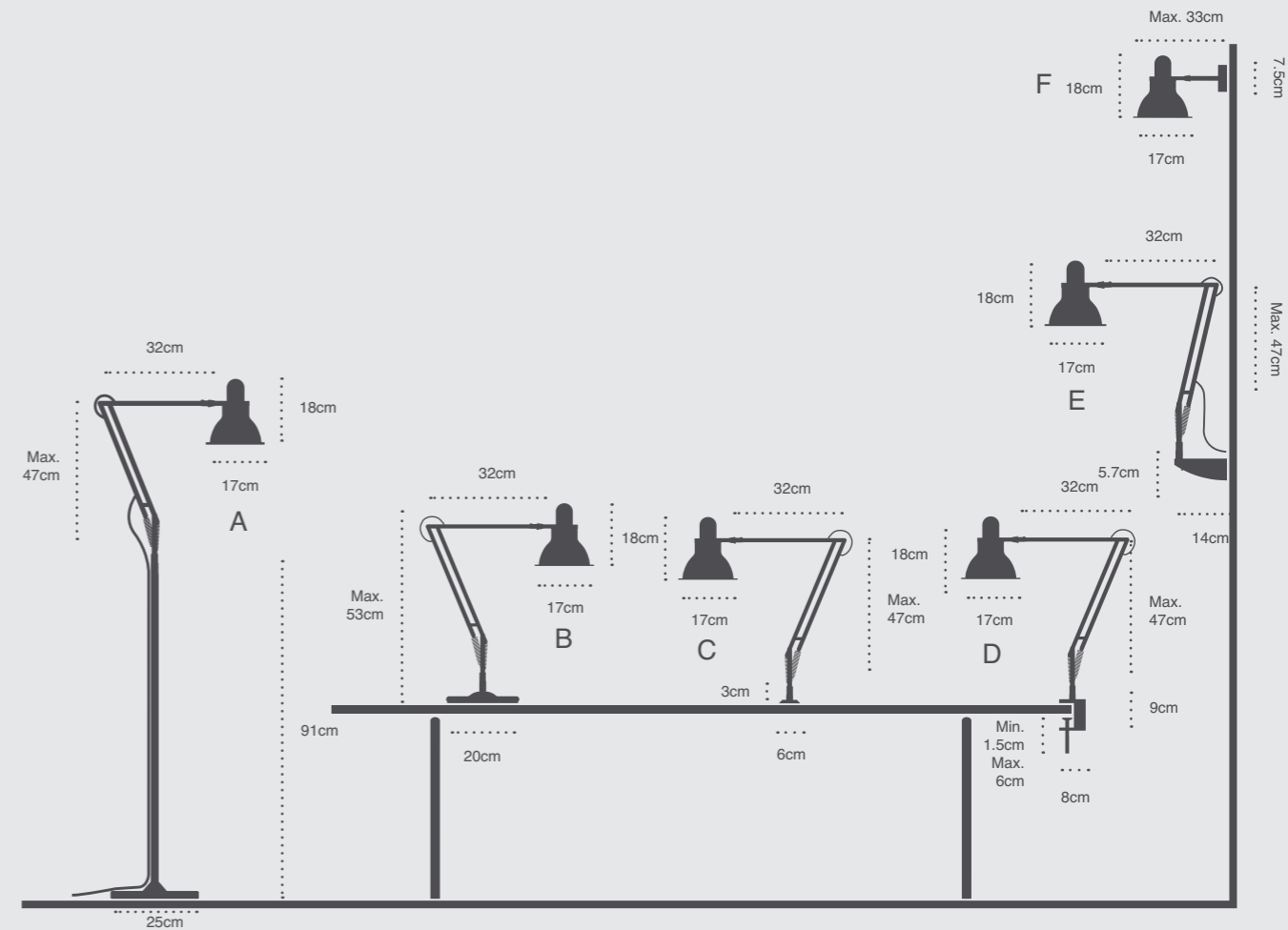
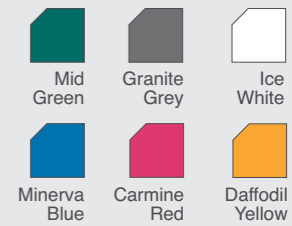

## Type C™ LED Desk Lamp

As beautiful as it is distinctive, the Type C™ design exploits LED energy efficiency to its maximum potential. Truly modern in design, the elegant glass shade incorporates a 6W CREE XPE LED replaceable module, delivering a very high quality and dimmable 'warm white' light output with 40,000 hours life expectancy.





**Type C™ LED Desk Lamp**  
Designed by Sir Kenneth Grange

Desk Lamp - A

Colours



Anodised  
Silver

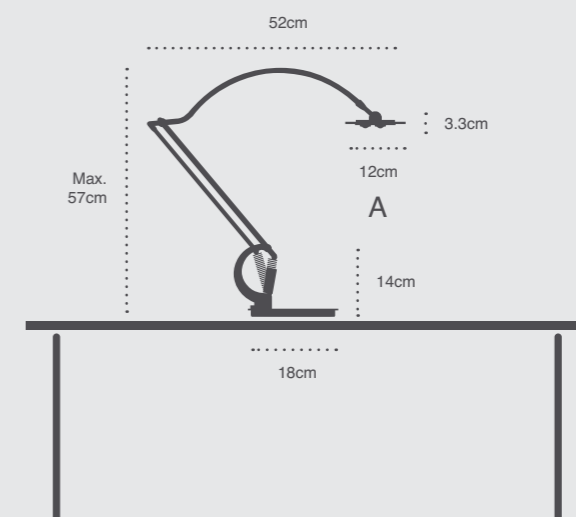

## Editions

---

The clean lines, flowing movement and no-frills functionality of Sir Kenneth Grange's classic Type 75™ make it a favourite with designers, so we have collaborated with two of Britain's best on a collection of Type 75™ Editions. Paul Smith has used his deftness with block colour to highlight the mechanical functionality of the desk lamp. Edition One sports vibrant, summery shades, while Edition Two acts as an alter ego in sumptuous, autumnal tones. Modernist aficionado Margaret Howell took a vintage 1970s Anglepoise® Model 90 as the starting point for her Yellow Ochre Type 75™ floor and desk lamps; an appropriate choice as the Model 90 inspired the very first Type 75™.



*Paul Smith*



## Anglepoise® + Margaret Howell Yellow Ochre Edition

British designer, and champion of Modernism, Margaret Howell is a life-long Anglepoise® fan, so when we invited her to create her own version of Sir Kenneth Grange's classic Type 75™ floor and desk lamps, she went back to the 1970s for inspiration. Her matt Yellow Ochre Type 75™ Edition is a precise colour match to the vintage Anglepoise® Model 90 she worked under as a child.



Anglepoise® + Margaret Howell  
Yellow Ochre Edition

Desk Lamp - A  
Floor Lamp - B

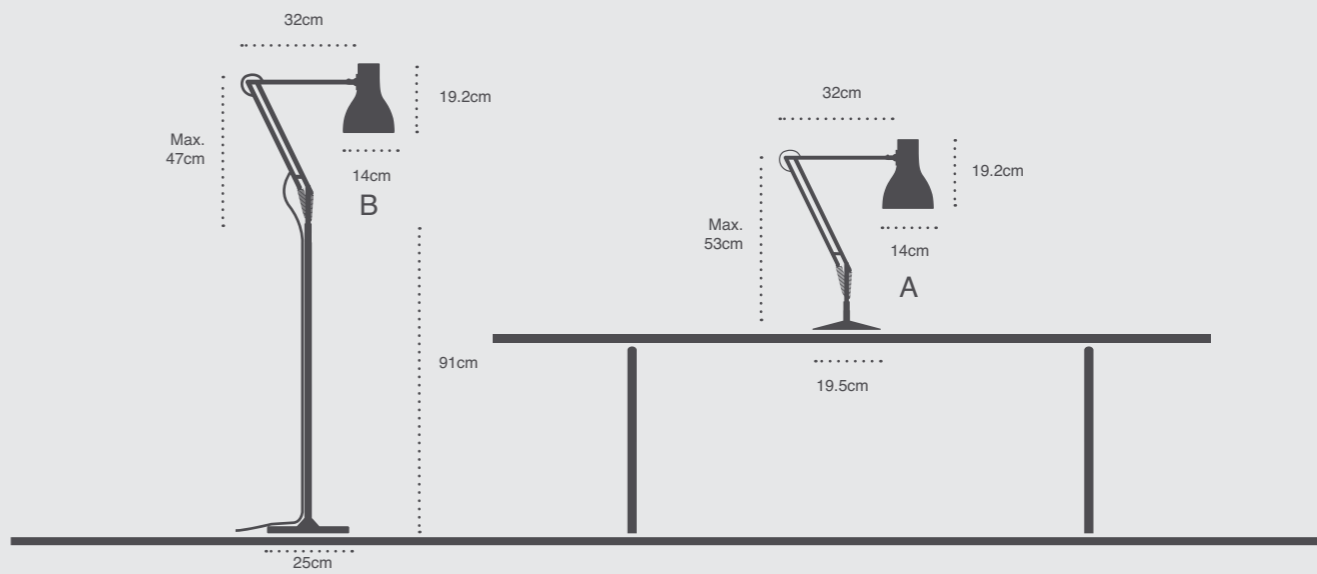



## Anglepoise® + Paul Smith Edition One

Paul Smith, one of Britain's foremost designers, has brought his quintessential style and mastery of colour to Sir Kenneth Grange's classic Anglepoise® Type 75™ desk lamp. Taking the lamp's modernist form as his palette, Paul Smith has used cornflower blue, fuchsia and lime colours to playfully articulate the product's mechanical functionality. The result is a witty, spirit-lifting interpretation of an enduring design classic.



Anglepoise® + Paul Smith Edition One

Desk Lamp - A

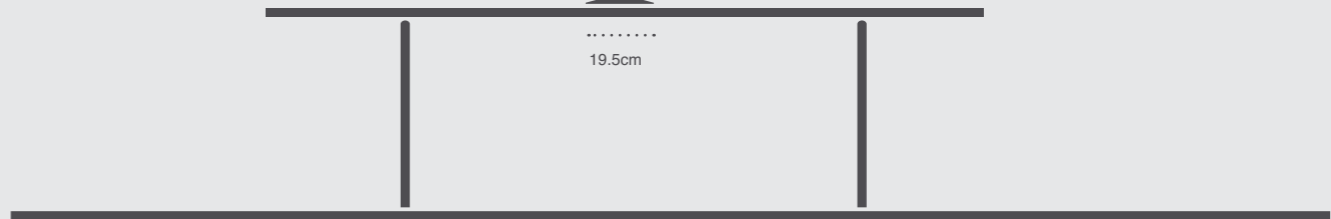
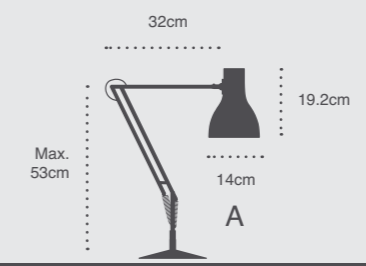



## Anglepoise® + Paul Smith Edition Two

Celebrated British designer Paul Smith has worked his magic on Sir Kenneth Grange's iconic Type 75™ table lamp once more. The designer's deftness with colour is back, cleverly highlighting the lamp's individual components, but where the Edition One was all about summer, its sibling offers a more autumnal palette of deep slate, cool grey and rich, jewel-like tones.



Anglepoise® + Paul Smith Edition Two

Desk Lamp - A

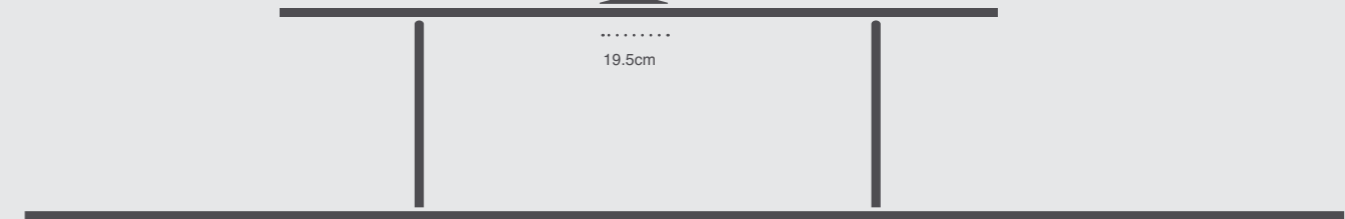
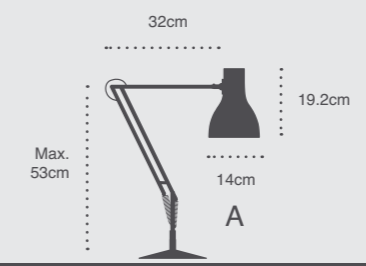



## Projects

Our high performance lamps are designed and built with longevity in mind. They are therefore also suited to the retail, hospitality, hotel and workplace sectors. We have incorporated flexibility into our collections to allow multiple variations, yet all remain true to the original Anglepoise® aesthetic.





### Aesop UK Headquarters

---

Jet Black Type 75™ Mini desk lamps with desk inserts form part of Aesop's new bright and elegant UK headquarters in London. Created by design studio Post-Office, the new space is located in a former manufacturing warehouse in Bloomsbury.

Design: Post-Office  
Photo: Ludger Paffrath



### Rapha

---

Jump Studios was commissioned to create an inspirational showroom and workspace within a refurbished two-storey former warehouse that would not only celebrate the culture of cycling, but also boost productivity and efficiency.

Design: Jump Studios  
Photo: Gareth Gardner



### Martyrs Kirk Reading Room

---

The University of St Andrews wanted to convert the newly acquired Martyrs Kirk into a post-graduate reading room for the Faculty of Arts. Page \ Park Architects successfully reconfigured and redefined the space to create a feeling of intimacy and academia whilst retaining the ecclesiastical nature of the architecture.

Interior Design: Page \ Park Architects  
Photo: Andrew Lee



## Camusdarach Sands

—

Anglepoise® Original 1227™ wall lights and wall mounted lamps form part of Raw Architecture Workshop's minimal and impressive new build house at Camusdarach Sands, Scotland.

Architect: Raw Architecture Workshop  
Photo: David Barbour



## Leo Burnett

—

Drawing on modern art galleries as their inspiration, Nefa Architects set about creating a dynamic space that would reflect the agency's roots in 1930's Chicago and evolve over time.

Architect: Nefa Architects  
Photo: Alexey Knyazev



## YOO Residences

—

Residential, commercial and hotel design company, YOO, delivers landmark projects all around the world. Our Original 1227™ Giant floor lamps have been commissioned by YOO for residential projects ranging from New Delhi in India to the Cotswolds, UK.

Above:  
The Lakes by YOO, UK  
Developer: YOO, The Raven Group  
Interior Design: YOO Studio  
Photo: Mel Yates

Left:  
YOO at Metropica, Miami  
Design: YOO Studio  
Developer: The Trillist Companies Inc.



## Ibsens Hotel

---

Ibsens urban boutique hotel is located right at the heart of the “Nansensgade” area, a village-like enclave hidden behind one of Copenhagen’s busiest pedestrian street, considered by the locals to epitomise “Nordic Cool”.

Interior Design: Morten Hedegaard (Proprietor)



## Metrix Consulting

---

Jet Black Anglepoise® Type 75™ desk lamps sit in Metrix Consulting’s cool and airy workspace in Melbourne, Australia. The space was designed by We Are Huntly, through Cult Design.

Interior Design: We Are Huntly  
Stylist: Marsha Golemac  
Photo: Tom Blachford



## 9Hotel Central

---

9HOTEL COLLECTION recently opened their third lifestyle hotel, located in the museum district of Brussels. Exposed structural elements in both the common areas and spacious loft-style bedrooms reveal the building’s rich history.

Architect: Castel Veciana Architectura Studio  
Interior Design: Skye Maunsell



## Ben Sherman

---

Icons of British design including a series of Anglepoise® lamps - some new, like the Original 1227™ Wall Mounted lamps in the Covent Garden store which opened November 2014, others historic collector's pieces, such as the white Model 90 desk lamp in the East London Commercial Street site - sit alongside carefully sourced vintage furniture in a clean and contemporary interior distinguished by the glazed white and brown tiling that has become a Ben Sherman trademark. The Shirt Bar, fashioned in dark stained wood reminiscent of original G-Plan furniture, creates a focal point in each store, reflecting this renowned British brand's fifty-year authority in shirting.

Interior Design: Brinkworth



## Bodega La Puntual

---

Conveniently located next to Barcelona's Picasso Museum, Bodega La Puntual effectively recreates the atmosphere of the traditional Spanish Bodegas. Taking full advantage of the dramatic potential of the lofty, double height restaurant space, architect Pedro Scattarella of DA2-arquitectura has created an atmospheric interior that echoes the past, yet feels relevant and contemporary. Multiple Original 1227™ Giant pendants in Pebble White and Warm Beige dominate the main dining hall, their oversized proportion giving a new twist to the classic Bodega-style interior.

Architect: Pedro Scattarella,  
DA2-Arquitectura  
Photo: Pedro Scattarella



## Boform Hellerup

---

Jet Black Anglepoise® Type 75™ Maxi pendants and a Type 75™ wall light feature in the cool and bright Boform Hellerup showroom in Copenhagen, designed by CPH Square.

Design: CPH Square, thanks to Møller og Rothe  
Photo: Morten Søby

# Product Index



This at-a-glance index itemises the full Anglepoise® product range, grouped by category: Table, Wall, Ceiling, Floor and Editions. Full collection details and colours can be found on the page listed beneath each photograph.



**Original 1227™ Mini Desk Lamp**  
Page 12



**Original 1227™ Desk Lamp**  
Page 18



**Original 1227™ Brass Desk Lamp**  
Page 28



**Type 75™ Desk Lamp - Paul Smith Edition One**  
Page 100



**Type 75™ Desk Lamp - Paul Smith Edition Two**  
Page 104



**Type C™ Desk Lamp**  
Page 90



**Original 1227™ Mini Table Lamp**  
Page 12



**Original 1227™ Table Lamp**  
Page 18



**Type 1228™ Desk Lamp**  
Page 84



**Type 1228™ with Desk Clamp**  
Page 84



**Type 75™ Mini with Desk Clamp**  
Page 58



**Type 75™ with Desk Clamp**  
Page 64



**Type 75™ Mini Desk Lamp**  
Page 58



**Type 75™ Desk Lamp**  
Page 64



**Type 75™ Desk Lamp - Margaret Howell Edition**  
Page 96



**Type 1228™ with Desk Insert**  
Page 84



**Type 75™ Mini with Desk Insert**  
Page 58



**Type 75™ with Desk Insert**  
Page 64



# Product Index



This at-a-glance index itemises the full Anglepoise® product range, grouped by category: Table, Wall, Ceiling, Floor and Editions. Full collection details and colours can be found on the page listed beneath each photograph.

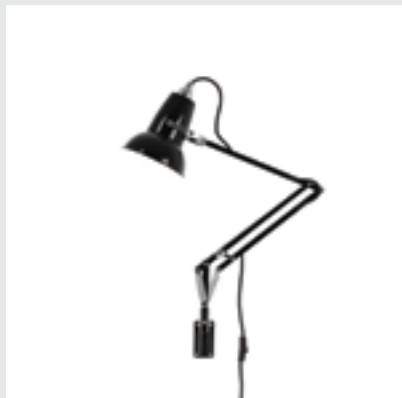

**Original 1227™ Mini Wall Mounted Lamp**  
Page 12



**Original 1227™ Wall Mounted Lamp**  
Page 18



**Original 1227™ Brass Wall Mounted Lamp**  
Page 28



**Original 1227™ Giant Floor Lamp Brass Collection**  
Page 48



**Type 75™ Maxi Floor Lamp**  
Page 70



**Type 75™ Giant Floor Lamp**  
Page 76



**Type 1228™ Wall Mounted Lamp**  
Page 84



**Type 75™ Mini Wall Mounted Lamp**  
Page 58



**Type 75™ Wall Mounted Lamp**  
Page 64



**Original 1227™ Fixed Floor Lamp**  
Page 18

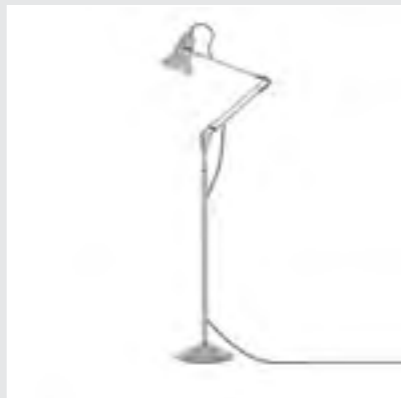

**Original 1227™ Floor Lamp**  
Page 18



**Type 1228™ Floor Lamp**  
Page 84



**Original 1227™ Giant Wall Mounted Lamp**  
Page 34

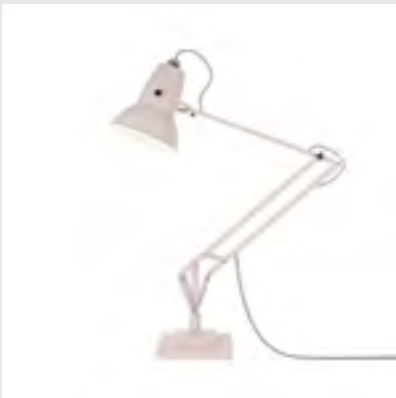

**Original 1227™ Giant Floor Lamp**  
Page 34



**Original 1227™ Giant Floor Lamp Outdoor**  
Page 42



**Type 75™ Mini Floor Lamp**  
Page 58



**Type 75™ Floor Lamp**  
Page 64



**Type 75™ Floor Lamp - Margaret Howell Edition**  
Page 96

# Product Index



This at-a-glance index itemises the full Anglepoise® product range, grouped by category: Table, Wall, Ceiling, Floor and Editions. Full collection details and colours can be found on the page listed beneath each photograph.



**Original 1227™ Pendant**  
Page 18



**Original 1227™ Brass Pendant**  
Page 28



**Original 1227™ Midi Pendant**  
Page 18

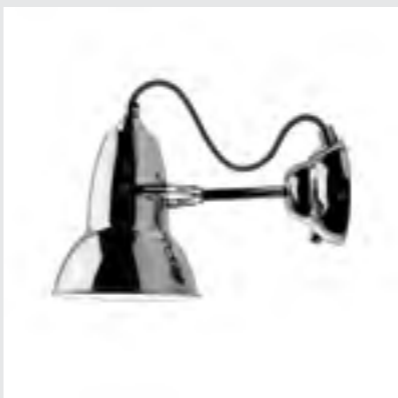

**Original 1227™ Wall Light**  
Page 18

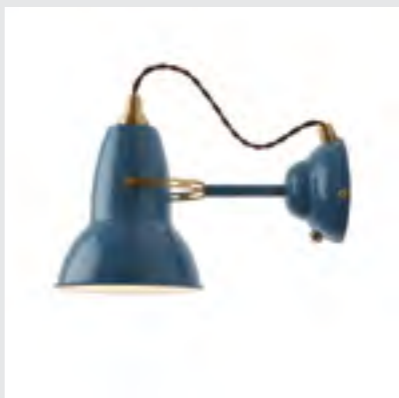

**Original 1227™ Brass Wall Light**  
Page 28

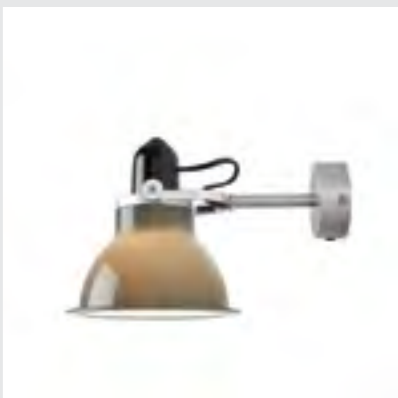

**Type 1228™ Wall Light**  
Page 84



**Original 1227™ Maxi Pendant**  
Page 18



**Original 1227™ Brass Maxi Pendant**  
Page 28



**Original 1227™ Giant Pendant**  
Page 34



**Type 75™ Mini Wall Light**  
Page 58



**Type 75™ Wall Light**  
Page 64



**Original 1227™ Giant Pendant  
Brass Collection**  
Page 48



**Type 75™ Maxi Pendant**  
Page 70



**Original 1227™ Mini Wall Light**  
Page 12



## Projects

Anglepoise® can support your project by offering:

- Industry competitive pricing
- Custom colour options
- UK / US / HK based stockholding
- Global support and servicing network
- International roll-out experience
- Global certification (CE, BSEN)
- CAD 2D / 3D Files
- Online technical-spec trade library
- Integrated desk / wall fixtures and fittings

## Contacts

[www.anglepoise.com](http://www.anglepoise.com)

@Anglepoise



We have offices in London, Portsmouth, New York and Hong Kong. For sales and press enquiries, please contact:

[sales@anglepoise.com](mailto:sales@anglepoise.com)  
[press@anglepoise.com](mailto:press@anglepoise.com)

## Photography

Original 1227™ Mini Collection, Original 1227™ Brass Collection, Type 75™ Maxi Collection & Anglepoise® + Paul Smith: Photos - Jake Curtis, Stylist - Despina Curtis

Pages 68, 74, 86, 88: Photos - Anders Schonemann, Stylist - Nathalie Schwer, for Cereal magazine

Original 1227™ Giant Brass Collection, Original 1227™ Giant Outdoor Collection & Type 75™ Giant Collection: Photos - Jake Curtis, Stylist - Hannah Simmons

Also thanks to:  
Skandium for the Marimekko vase & Kubos brass bowl & to Mud Australia for the porcelain ceramics featured in the Original 1227™ & Original 1227™ Giant Brass photos.

Mud Australia for the porcelain ceramics & to Imogen Heath for the cushions featured in Type 75™ Giant & Original 1227™ photos.

Triangle for the desk objects, Darkroom for the globe, Eleanor Pritchard for the throw, & to twentytwentyone & SCP for ceramics featured in the Original 1227™ Mini photos.

Triangle for providing geometric shapes & to Darkroom for the ceramics featured in the Original 1227™ Brass & Type 75™ Maxi photos.

Page 4: Cyanotype Print, Russell Squires  
Page 5: Paul Smith Portrait, James Mooney

## Credits

13	Vitra	Compas Direction Desk
	Vitra	Tabouret Solvay Stool
	Another Country	Bedside Table
19	Another Brand	Cubo Side Table
20	Knoll	Black Bertoia Side Chair
	Another Country	Coffee Table
21	Another Brand	Cubo Square Cabinet
24	Knoll	Nakashima Walnut Straight Chair
26	Mooodi	Tudor low cupboard
	Vitra	Soft pad Eames Chair
	Vitra	Alvar Aalto Stool
	Modus	Bloom Table
30	Vitra	Wire DKW Chair
	Nigel O'Neill	Artwork, Paul Smith
32	Benchmark	Victoria Dining Table
	Benchmark	Victoria Bench
	Vitra	Wire DKW Chair
36	Vitra	Eames RAR Chair
	Vitra	Plate Marble Top Side Table
	twentytwentyone	Zero Bamboo Mirrors
	Ptolemy Mann	Indigo Colourfield Gelim Rug
38	Another Brand	Cubo Rectangular Table
	Another Brand	Cubo Dining Chair
40	Another Brand	Cubo Wood Bench
43	twentytwentyone	Tio Outdoor Table & Chairs
	Knoll	Bertoia Diamond Chairs
44	Skandium	Ferm Living Planter
	Knoll	Bertoia Side Chair
50	Another Country	Sideboard Two
	Another Country	Dining Table Two
	Another Country	Bench Two
	Another Country	Another Chairs
	Skandium	Marimekko Urna Vase
52	Another Country	Dining Table Two
	Another Country	Another Chairs
	Skandium	Kubos Brass Bowl
54	Another Country	Desk Three & Accessories
	Knoll	Bertoia Side Chair
60	Pinch	Lyle Console
62	Ercol	Love seat
65	Modus	Angle Sofa
	Pinch	Lowry Sideboard
66	Børge Mogensen	Søborg Chairs
	Arne Jacobsen	Circular Table
68	Christophe de la Fontaine	Drinks Cart
	Another Country	Daybed Two
72	Another Brand	Cubo Wood Bench
77	Another Brand	Tavolini Primo Table
	Another Brand	Tavolini Strada Tables
78	Knoll	Risom Lounge Chair
80	Ercol	Butterfly Chair
85	Ercol	Table & Vases
86	Klassik	Ax Stool by Hvidt & Nielsen
88	Klassik	V Table
92	Modus	Furniture & Accessories
101-106	Paul Smith	